

# Electro/Pneumatic Converter

Models 8064A and 8064C

## Typical applications

- Controls AMOT pneumatic temperature control valves (G valve)
- Converts a 4 to 20 mA input signal to a directly proportional 0.2 to 1 bar (3 to 15 psi) pneumatic output signal

## Key benefits 8064A

- High vibration resistance - Lloyds Marine
- Suitable for longer pipe runs
- Fully adjustable for optimised system operation
- ATEX hazardous area certification



8064A

## Key benefits - 8064C

- Accepts high supply pressure - avoids use of additional regulator
- Factory set for ease of installation
- Low cost alternative to 8064A
- ATEX hazardous area certification



8064C

**amot**

[www.amot.com](http://www.amot.com)

# Electro/Pneumatic Converter - Models 8064A & 8064C

## Overview - 8064A



**8064A**

Using a clean, regulated air supply, model 8064A transducer provides a 3 - 15 psig pneumatic output which is proportional to a DC milliamp input. The mechanism is damped with a viscous silicone fluid, making it insensitive to shock and vibration.

Model 8064A may be specified with output either direct or reverse acting, increasing or decreasing with an increasing input.

## Application

### Electro-pneumatic system

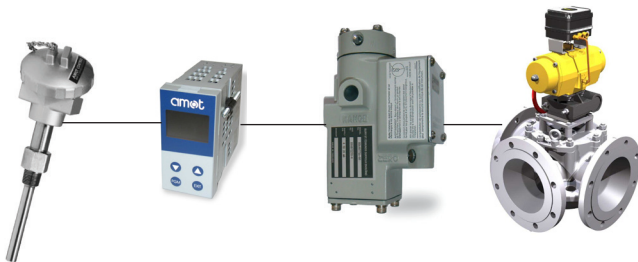

Temperature probe  
8060

Temperature controller  
8071D

Electro-pneumatic converter  
8064A

G valve

The electro-pneumatic valve system (see datasheet Datasheet\_G\_temperature\_control\_valve) combines both electric and pneumatic technology, consisting of a pneumatically actuated three-way control valve with an electro-pneumatic converter.

The probe sends a resistance signal to the electronic controller, which in turn sends a 4 to 20mA signal to the 8064A I/P converter that converts this to a pneumatic signal.

The electro-pneumatic system combines the features and functionality of the AMOT electronic control system with the fail-safe action benefits of a pneumatically actuated valve.

## Dimensions - 8064A

### Dimensions in mm (inches)

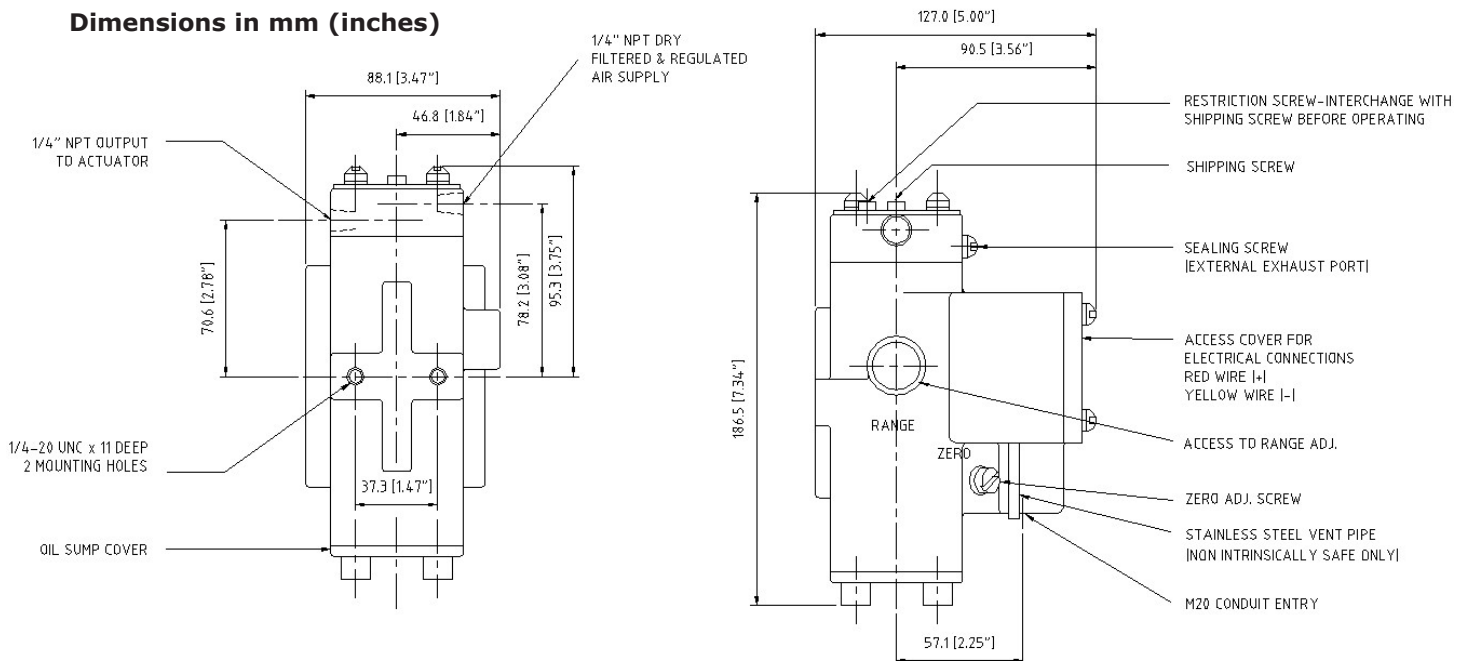

# Electro/Pneumatic Converter - Models 8064A & 8064C

---

## Specification - 8064A

<b>Supply pressure</b>	1.3 to 2.1 bar	(18 to 30 psi)
<b>Input</b>	4 to 20 mA	
<b>Output</b>	0.2 to 1 bar	(3 to 15 psi)
<b>Zero offset adjustment</b>	+40% to -20% of span	
<b>Output capacity</b>	0.16 SCFM	
<b>Output volume</b>	170 cc maximum recommended	
<b>Response level</b>	0.025% of span	
<b>Calibration accuracy</b>	0.25% of span	
<b>Supply pressure effect</b>	Less than 1% of span	
<b>Ambient temperature limit</b>	-40°C to +80°C	(-40°F to +180°F)
<b>Coil resistance</b>	185 Ohms	
<b>Vibration</b>	5 - 100 Hz 4g (Lloyds Register Type Approval System Test Specification Number 1 2002 - Vibration Test 2)	
<b>Body material</b>	Cast iron	
<b>Top housing &amp; terminal cover</b>	Aluminium	
<b>Paint finish</b>	Epoxy powder	
<b>Weight</b>	4.5 kg	(10.5 lbs)
<b>Mounting</b>	Vertical only	
<b>Hazardous area certification</b>	ATEX EEx ia IIC T6	

# Electro/Pneumatic Converter - Models 8064A & 8064C

## Overview - 8064C



The 8064C Proportional I/P Converter uses advanced closed loop solid-state electronic control to achieve accurate, high resolution pressure control.

It is available in intrinsically safe and non-incendive type nL versions and its minimum vibration effect and IP66 weatherproof rating make it ideal for field application.

## Application

### Electro-pneumatic system

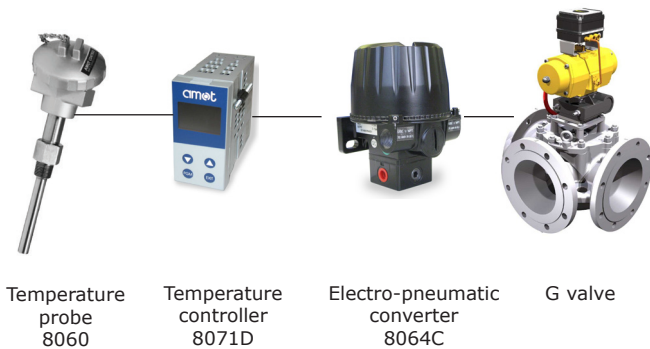

The electro-pneumatic valve system (see Datasheet\_G\_temperature\_control\_valve) combines both electric and pneumatic technology, consisting of a pneumatically actuated three-way control valve with an electro-pneumatic converter.

The probe sends a resistance signal to the electronic controller, which in turn sends a 4 to 20mA signal to the 8064C I/P converter that converts this to a pneumatic signal.

The electro-pneumatic system combines the features and functionality of the AMOT electronic control system with the fail-safe action benefits of a pneumatically actuated valve.

## Dimensions - 8064C

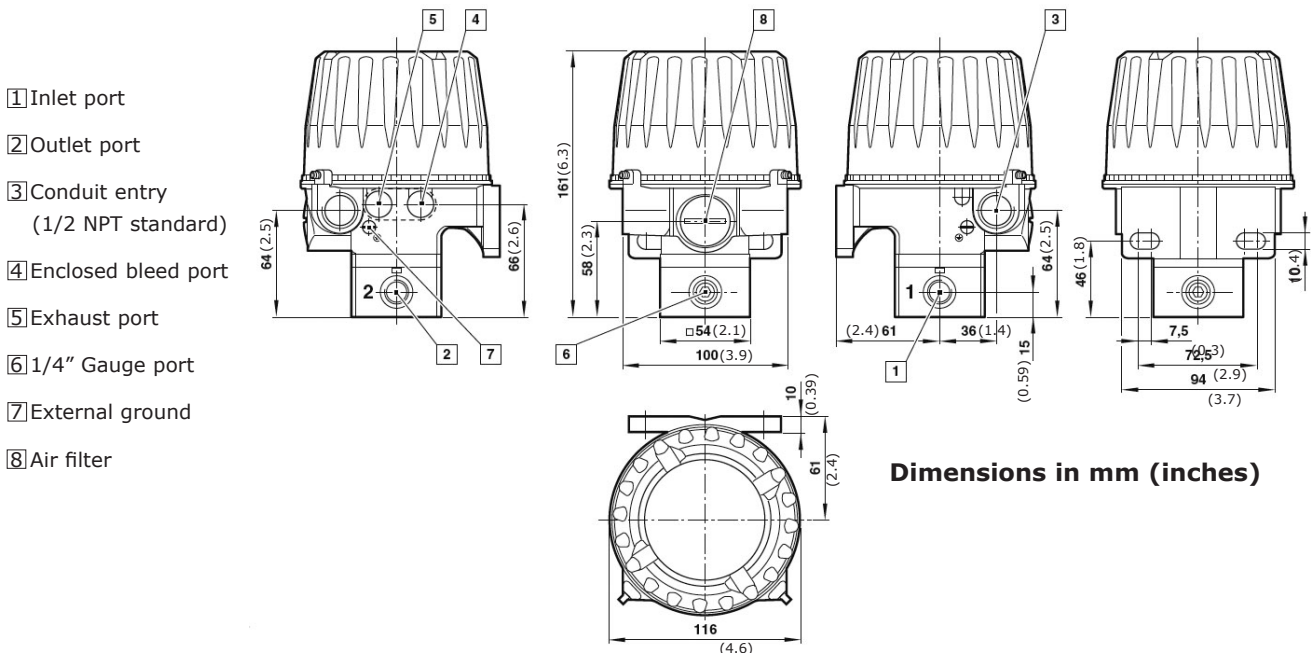

# Electro/Pneumatic Converter - Models 8064A & 8064C

## Specification - 8064C

### Pneumatic

<b>Supply pressure</b>	1.2 to 10 bar	(18 to 150 psi)
<b>Output</b>	0.2 to 1 bar	(3 to 15 psi)
<b>Supply sensitivity</b>	Less than 0.1% span over full supply pressure range	
<b>Flow</b>	Max 300N l/min	(12 scfm)
<b>Air consumption</b>	<2.5N l/min at 50% signal	(0.025 cfm)
<b>Temperature effect</b>	Typically less than 0.035% of span/°C between -40°C to +85°C (-40°F to +185°F)	
<b>Response time</b>	1 sec (from 0 to 90% or 100 to 10% of output pressure into a 0.5 litre load)	
<b>Degree of protection</b>	IP66, NEMA 4X (when mounted upright)	
<b>Linearity</b>	<0.1% of span	
<b>Hysteresis</b>	<0.1% of span	

### Physical

<b>Ambient temperature</b>	-40°C to +85°C Contact us for use below +2°C (35°F)	(-40°F to +185°F)
<b>Vibration immunity</b>	Output pressure changes less than 3% for vibration amplitude 4mm 5 - 15 Hz, 2g 15 - 150 Hz	
<b>Weight</b>	2.07 kg	4.5 lb
<b>Calibration</b>	Independent control of 0% and 100% set points. Adjustable by potentiometers up to 20% of output range. Unit is factory calibrated to within 1% of span.	
<b>Materials</b>	Body	Aluminium and zinc diecasting
	Diaphragms	Nitrile
	Black epoxy powder coating standard	
<b>Electromagnetic compatibility</b>	CE marked	Conforms to EC requirements EN 50081-2 (1994) and EN 50082-2 (1995)

### Electrical



<b>Electrical input signal</b>	4 - 20 mA (two wire) Terminal voltage <6.5V @20mA	
<b>Failure mode</b>	Signal falls to below 15 mbar (0.2 psi) in <2 sec, when input signal fails	
<b>Overload protection</b>	100 mA max overload current	
<b>Insulation resistance</b>	>100 mΩ at 850V dc electrical terminals to case	
<b>Tight shut off</b>	Adjustable up to 4.5 mA to achieve tight shut off	
<b>Input impedance</b>	The impedance changes with applied current because its terminal voltage remains fairly constant, therefore: 4 mA = approx 1370Ω 12 mA = approx 470Ω 20 mA = approx 290Ω	
<b>Connections</b>	1/2" NPT or M 20; internal terminal block with capacity up to 2.5 mm <sup>2</sup> cable	

# Electro/Pneumatic Converter - Models 8064A & 8064C

## Specification - 8064C cont'd

Actuation	Port Size	Max Flow (N L/min)	Output Pressure	Port
	G1/4	300	0.2 - 1 bar	BSP
	G1/4	300	3 - 15 psi	BSP

## Certification 8064C

Certification Agency	Explosion proof/ flame proof	Intrinsically safe	Type N/Non-incendive	Others
<b>SIRA</b> <b>(CENELEC ATEX approved)</b> 	EEx d IIC T4 Ta=-20°C to +40°C EExd IIB+H <sub>2</sub> T5/T6 Ta=-20°C to +80°C (T5) Ta=-20°C to +65°C (T6) Umax=30V Sira 01ATEX1006 2G (T4/T5/T6)/2D (95°C)	EEx ia IIC T4 Ta=-40°C to +85°C Ui=30V, li=110mA Pi=0.84W Ci=6nF, Li=100µH Sira 01ATEX2007X 1G (T4)/1D (95°C)	EEx nL IIC T5 Ta=-40°C to +85°C li=24mA Ci=6nF Li=100µH Sira 01ATEX4008X 3G(T5)/3D (95°C)	
<b>Factory Mutual</b> 	Class I, Division 1, Group B, C, D; T6, Ta=75°C T5, Ta=85°C	Class I, II, III, Division 1, Group A, B, C, D, E, F, G; T4, Ta=85°C	Class I, Division 2, Group A, B, C, D; T6, Ta=75°C T5, Ta=85°C	<b>Dust Ingress Protection:</b> Class II, III, Division 1, Group E, F, G; T6, Ta=75°C T5, Ta=85°C  <b>Suitable for:</b> Class II, III, Division 2, Group F, G; T6, Ta=75°C T5, Ta=85°C
<b>CSA</b> 	Class I, Group B, C, D; Class II, Group E, F, G; Class III; Ex d IIC;T4 Ex d IIB+H <sub>2</sub> ; T5/T6	Class I, Group A, B, C, D Class II, Group E, F, G Class III EX ia IIC; T4	Class I, Division 2, Group A, B, C, D; Ex nL IIC; T5 Class II, Division 2 Group E, F, G; Class III	

## How to order

Use the table below to select the unique specification of your 8064A converter:

Example code	8064A	7716	-AA	Code Description
Model & revision level				Model & revision level
	8064A			Converter
Type				Type
		7716		Direct acting - output increases as input increases
Customer special options				Customer special options
			-AA	Standard product
			-**	Customer special code assigned

The 8064C is supplied as a standard unit. You will need to state the code below when ordering.  
Code: 8064C00-AA

Example code	8064C00	-AA	Code Description
Model & revision level			Model & revision level
	8064C00		Converter
Customer special options			Customer special options
		-AA	Standard product
		-**	Customer special code assigned

## Europe, Middle East and Africa

---

AMOT  
Western Way  
Bury St Edmunds  
Suffolk, IP33 3SZ  
England

Tel +44 (0) 1284 762222  
Fax +44 (0) 1284 760256  
Email info@amot.com

AMOT Controls GmbH  
Rondenbarg 25  
22525 Hamburg  
Germany

Tel +49 (0) 40 8537 1298  
Fax +49 (0) 40 8537 1331  
Email germany@amot.com

## Asia Pacific

---

AMOT Shanghai  
Rm 4102, United Plaza  
1468 Nanjing Road West  
Shanghai 200040  
China

Tel +86 (0) 21 6279 7700  
Fax +86 (0) 21 5237 8560  
Email shanghai@amot.com

AMOT Singapore  
10 Eunos Road 8 #12-06  
Singapore Post Centre  
Singapore 408600

Tel +65 6408 6265  
Fax +65 6293 3307  
Email singapore@amot.com

## Americas

---

AMOT USA  
8824 Fallbrook Dr  
Houston, TX 77064  
USA

Tel +1 (281) 940 1800  
Fax +1 (713) 559 9419  
Email general: sales@amotusa.com  
orders: orders@amotusa.com  
customer service: cs@amotusa.com